

1-Bit Dual-Supply Unidirectional Bus Transceiver

1 FEATURES

- **Power-Supply Range:**
 V_{CCA} and V_{CCB} : 1.65V to 5.5V
- **V_{CC} Isolation:** If Either V_{CC} is at GND, Both Ports are in the High-Impedance State
- **Low power consumption, 4 μ A Max**
- **Output drive up to ± 24 mA @3.0V**
- **No Power-Supply Sequencing Required:** Either V_{CCA} or V_{CCB} can be Ramped First
- **I_{OFF} :** Supports Partial-Power-Down Mode Operation
- **Extended Temperature:** -40°C to +125°C

2 APPLICATIONS

- Industrial
- Enterprise
- Telecom, such as VOIP
- Personal electronic

3 DESCRIPTIONS

The RS1T34 is 1-bit non-inverting bus transceiver uses two separate configurable power supply rails. The A port is designed to track V_{CCA} , which supporting operating voltages from 1.65V to 5.5V, and the B port supporting operating voltages from 1.65V to 5.5V while it tracks the V_{CCB} supply. This allows for universal low-voltage unidirectional translation between any of the 1.8V, 2.5V, 3.3V and 5V voltage nodes.

The RS1T34 is designed for asynchronous communication between two data buses. The A bus is input side, the B bus is output side.

The RS1T34 is fully specified for partial power-down applications using I_{off} . The I_{off} circuitry disables the outputs, preventing damaging current backflow through the device when it is powered down.

The RS1T34 is available in Green SOT23-5 and SOT353(SC70-5) packages. It operates over an ambient temperature range of -40°C to +125°C.

Device Information⁽¹⁾

PART NUMBER	PACKAGE	BODY SIZE (NOM)
RS1T34	SOT23-5(5)	2.92mm×1.60mm
	SC70-5 (SOT353) (5)	2.10mm×1.25mm

(1) For all available packages, see the orderable addendum at the end of the data sheet.

4 Functional Block Diagram

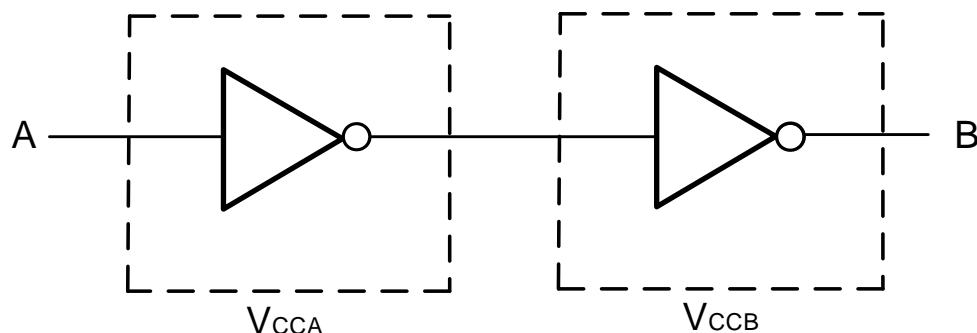

Table of Contents

1 FEATURES	1
2 APPLICATIONS	1
3 DESCRIPTIONS	1
4 Functional Block Diagram	1
5 Revision History	3
6 PACKAGE/ORDERING INFORMATION ⁽¹⁾	4
7 PIN CONFIGURATIONS	5
7.1 PIN DESCRIPTION	5
7.2 Function Table ⁽²⁾	5
8 SPECIFICATIONS	6
8.1 Absolute Maximum Ratings	6
8.2 ESD Ratings.....	6
8.3 Recommended Operating Conditions.....	7
8.4 Electrical Characteristics.....	8
8.5 Timing Requirements.....	9
8.5.1 $V_{CCA}=1.8V\pm 0.15V$	9
8.5.2 $V_{CCA}=2.5V\pm 0.2V$	9
8.5.3 $V_{CCA}=3.3V\pm 0.3V$	9
8.5.4 $V_{CCA}=5V\pm 0.5V$	9
8.6 Operating Characteristics	9
8.7 Typical Characteristics.....	10
9 Parameter Measurement Information	11
10 Application Information	12
11 PACKAGE OUTLINE DIMENSIONS	13
12 TAPE AND REEL INFORMATION	15

5 Revision History

Note: Page numbers for previous revisions may differ from page numbers in the current version.

VERSION	Change Date	Change Item
A.1	2021/09/29	Initial version completed
A.2	2022/12/14	<ol style="list-style-type: none">1. Update PACKAGE MARKING on Page 5@RevA.12. Update ESD Ratings on Page 4@RevA.13. Changed Recommended Operating Conditions and Timing Requirements and Operating Characteristics

6 PACKAGE/ORDERING INFORMATION ⁽¹⁾

PRODUCT	ORDERING NUMBER	TEMPERATURE RANGE	PACKAGE LEAD	PACKAGE MARKING ⁽²⁾	MSL ⁽³⁾	PACKAGE OPTION
RS1T34	RS1T34XF5	-40°C ~+125°C	SOT23-5	1T34	MSL3	Tape and Reel,3000
	RS1T34XC5	-40°C ~+125°C	SOT353 (SC70-5)	1T34	MSL3	Tape and Reel,3000

NOTE:

- (1) This information is the most current data available for the designated devices. This data is subject to change without notice and revision of this document. For browser-based versions of this data sheet, refer to the right-hand navigation.
- (2) There may be additional marking, which relates to the lot trace code information(data code and vendor code), the logo or the environmental category on the device.
- (3) MSL, The Moisture Sensitivity Level rating according to the JEDEC industry standard classifications.

7 PIN CONFIGURATIONS

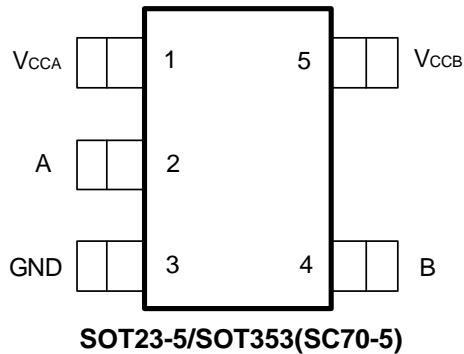

7.1 PIN DESCRIPTION

PIN	NAME	TYPE ⁽¹⁾	FUNCTION
SOT23-5/SOT353(SC70-5)			
1	V _{CCA}	P	A Port Supply Voltage. $1.65V \leq V_{CCA} \leq 5.5V$
2	A	I	Input A. Reference to V _{CCA} .
3	GND	–	Ground.
4	B	O	Output B. Reference to V _{CCB} .
5	V _{CCB}	P	B Port Supply Voltage. $1.65V \leq V_{CCB} \leq 5.5V$.

(1) I=input, O=output, P=power.

7.2 Function Table ⁽²⁾

INPUT ⁽¹⁾	OUTPUT
A PORT ⁽³⁾	B PORT ⁽³⁾
H	H
L	L

Note:

- (1) The input circuit of the data I/O is always active.
- (2) When either V_{CCA} or V_{CCB} is at GND level, the device goes into suspend mode.
- (3) H=High voltage level, L=Low voltage level.

8 SPECIFICATIONS

8.1 Absolute Maximum Ratings

Over operating free-air temperature range (unless otherwise noted) ⁽¹⁾

SYMBOL	PARAMETER		MIN	MAX	UNIT
V _{CCA} ⁽³⁾	Supply Voltage Range		-0.5	6.5	V
V _{CCB} ⁽³⁾	Supply Voltage Range		-0.5	6.5	V
V _I ⁽²⁾	Input Voltage Range	A port	-0.5	6.5	V
V _O ⁽²⁾	Voltage range applied to any output in the high-impedance or power-off state	B port	-0.5	V _{CCB} +0.5	V
I _{IK}	Input clamp current	V _I <0		-50	mA
I _{OK}	Output clamp current	V _O <0		-50	mA
I _O	Continuous output current			±50	mA
	Continuous current through V _{CCA} , V _{CCB} or GND			±100	mA
θ _{JA}	Package thermal impedance ⁽⁴⁾	SOT23-5		230	°C/W
		SOT353(SC70-5)		376	
T _J	Junction temperature ⁽⁵⁾		-40	150	°C
T _{stg}	Storage temperature		-65	+150	

(1) Stresses beyond those listed under *Absolute Maximum Ratings* may cause permanent damage to the device. These are stress ratings only, which do not imply functional operation of the device at these or any other conditions beyond those indicated under *Recommended Operating Conditions*. Exposure to absolute-maximum-rated conditions for extended periods may affect device reliability.

(2) The input and output negative-voltage ratings may be exceeded if the input and output current ratings are observed.

(3) The value of V_{CCA} and V_{CCB} are provided in the recommended operating conditions table.

(4) The package thermal impedance is calculated in accordance with JESD-51.

(5) The maximum power dissipation is a function of T_{J(MAX)}, R_{θJA}, and T_A. The maximum allowable power dissipation at any ambient temperature is P_D = (T_{J(MAX)} - T_A) / R_{θJA}. All numbers apply for packages soldered directly onto a PCB.

8.2 ESD Ratings

The following ESD information is provided for handling of ESD-sensitive devices in an ESD protected area only.

			VALUE	UNIT
V _(ESD)	Electrostatic discharge	Human-body model (HBM), per ANSI/ESDA/JEDEC JS-001 ⁽¹⁾	±2000	V
		Charged-device model (CDM), per ANSI/ESDA/JEDEC JS-002 ⁽²⁾	±1500	V
		Machine Model (MM)	±200	V

(1) JEDEC document JEP155 states that 500 V HBM allows safe manufacturing with a standard ESD control process.

(2) JEDEC document JEP157 states that 250 V CDM allows safe manufacturing with a standard ESD control process.



ESD SENSITIVITY CAUTION

ESD damage can range from subtle performance degradation to complete device failure. Precision integrated circuits may be more susceptible to damage because very small parametric changes could cause the device not to meet its published specifications.

8.3 Recommended Operating Conditions

V_{CCA} is the supply voltage associated with the input port. V_{CCB} is the supply voltage associated with the output port.

PARAMETER		V_{CCA} (1)	V_{CCB} (2)	MIN	TYP	MAX	UNIT
Supply voltage (1)	V_{CCA}			1.65		5.5	V
	V_{CCB}			1.65		5.5	
High-level input Voltage	V_{IH} (4)	1.65V to 1.95V		$V_{CCA} \times 0.75$			V
		2.3V to 2.7V		$V_{CCA} \times 0.7$			
		3V to 3.6V		$V_{CCA} \times 0.7$			
		4.5V to 5.5V		$V_{CCA} \times 0.7$			
Low-level input Voltage	V_{IL} (4)	1.65V to 1.95V				$V_{CCA} \times 0.35$	V
		2.3V to 2.7V				$V_{CCA} \times 0.3$	
		3V to 3.6V				$V_{CCA} \times 0.3$	
		4.5V to 5.5V				$V_{CCA} \times 0.3$	
Input voltage	V_I			0		5.5	V
Output voltage	V_O			0		V_{CCB}	V
High-level output current (I_{OH})			1.65V to 1.95V			-4	mA
			2.3V to 2.7V			-8	
			3V to 3.6V			-24	
			4.5V to 5.5V			-32	
Low-level output current (I_{OL})			1.65V to 1.95V			4	mA
			2.3V to 2.7V			8	
			3V to 3.6V			24	
			4.5V to 5.5V			32	
Input transition rise or fall rate($\Delta t/\Delta v$)	Data inputs (3)	1.65V to 1.95V				20	ns/V
		2.3V to 2.7V				20	
		3V to 3.6V				10	
		4.5V to 5.5V				5	
T_A Operating free-air temperature				-40		125	°C

(1) V_{CCA} is the V_{CC} associated with the data input port.

(2) V_{CCB} is the V_{CC} associated with the output port.

(3) All unused or driven (floating) data inputs (I/Os) of the device must be held at logic HIGH or LOW (preferably V_{CCI} or GND) to ensure proper device operation and minimize power.

(4) For V_{CCA} values not specified in the data sheet, $V_{IH \text{ min}} = V_{CCA} \times 0.7 \text{ V}$, $V_{IL \text{ max}} = V_{CCA} \times 0.3 \text{ V}$.

8.4 Electrical Characteristics

over recommended operating free-air temperature range (unless otherwise noted) ^{(1) (2)}

PARAMETER		CONDITIONS	V _{CCA}	V _{CCB}	TEMP	MIN ⁽³⁾	TYP ⁽⁴⁾	MAX ⁽³⁾	UNIT
V _{OH}		I _{OH} = -100μA V _I =V _{IH}	1.65V to 4.5V	1.65V to 4.5V	Full	V _{CCB} - 0.1			V
		I _{OH} = -4mA V _I =V _{IH}	1.65V	1.65V		1.2			
		I _{OH} = -8mA V _I =V _{IH}	2.3V	2.3V		1.9			
		I _{OH} = -24mA V _I =V _{IH}	3V	3V		2.4			
		I _{OH} = -32mA V _I =V _{IH}	4.5V	4.5V		3.8			
V _{OL}		I _{OL} = 100μA V _I =V _{IL}	1.65V to 4.5V	1.65V to 4.5V	Full			0.1	V
		I _{OL} = 4mA V _I =V _{IL}	1.65V	1.65V				0.45	
		I _{OL} = 8mA V _I =V _{IL}	2.3V	2.3V				0.3	
		I _{OL} = 24mA V _I =V _{IL}	3V	3V				0.55	
		I _{OL} = 32mA V _I =V _{IL}	4.5V	4.5V				0.55	
I _I	Input leakage current	V _I = V _{CCA} or GND	1.65V to 5.5V	1.65V to 5.5V	+25°C			±1	μA
					Full			±2	
I _{off}	A or B Port	V _I or V _O = 0 to 5.5V	0V	0V to 5.5V	+25°C			±1	μA
					Full			±2	
			0V to 5.5V	0V	+25°C			±1	μA
					Full			±2	
I _{CCA}	V _{CCA} supply current	V _I = V _{CCA} or GND ⁽⁵⁾ I _O = 0	1.65V to 5.5V	1.65V to 5.5V	Full			3	μA
			5V	0V	Full			2	
			0V	5V	Full			-2	
I _{CCB}	V _{CCB} supply current	V _I = V _{CCA} or GND ⁽⁵⁾ I _O = 0	1.65V to 5.5V	1.65V to 5.5V	Full			3	μA
			5V	0V	Full			-2	
			0V	5V	Full			2	
I _{CCA} + I _{CCB}	Combined supply current	V _I = V _{CCA} or GND I _O = 0	1.65V to 5.5V	1.65V to 5.5V	Full			4	μA
ΔI _{CCA}	A port	One A port at V _{CCA} - 0.6 V, B port = open	3V to 5.5V	3V to 5.5V	Full			50	μA
ΔI _{CCB}	B port	One B port at V _{CCB} - 0.6 V, A port = open	3V to 5.5V	3V to 5.5V	Full			50	μA
C _I	Input capacitance	V _I = GND or V _{CCA}	0V to 3.6V	0V to 3.6V	+25°C		8.5		pF
C _O	Output capacitance	V _O =GND	0V to 3.6V	0V to 3.6V	+25°C		8.5		pF

(1) V_{CCA} is the V_{CC} associated with the input port.

(2) V_{CCB} is the V_{CC} associated with the output port.

(3) Limits are 100% production tested at 25°C. Limits over the operating temperature range are ensured through correlations using statistical quality control (SQC) method.

(4) Typical values represent the most likely parametric norm as determined at the time of characterization. Actual typical values may vary over time and will also depend on the application and configuration.

(5) Hold all unused data inputs of the device at V_{CCI} or GND to assure proper device operation.

8.5 Timing Requirements

8.5.1 $V_{CCA}=1.8V\pm 0.15V$

over recommended operating free-air temperature range, Full=-40°C to 125°C.

PARAMETER	FROM (INPUT)	TO (OUTPUT)	TEMP	$V_{CCB}=1.8V \pm 0.15V^{(1)}$		$V_{CCB}=2.5V \pm 0.2V^{(1)}$		$V_{CCB}=3.3V \pm 0.3V^{(1)}$		$V_{CCB}=5V \pm 0.5V^{(1)}$		UNIT
				MIN	MAX	MIN	MAX	MIN	MAX	MIN	MAX	
t_{PLH}	A	B	Full	3.5	24.6	2.6	17.2	2	18.6	1.6	18.5	ns
t_{PHL}				3.3	18.4	2.6	15.5	2.1	16.4	2	16.8	

(1) This parameter is ensured by design and/or characterization and is not tested in production.

8.5.2 $V_{CCA}=2.5V\pm 0.2V$

over recommended operating free-air temperature range, Full=-40°C to 125°C.

PARAMETER	FROM (INPUT)	TO (OUTPUT)	TEMP	$V_{CCB}=1.8V \pm 0.15V^{(1)}$		$V_{CCB}=2.5V \pm 0.2V^{(1)}$		$V_{CCB}=3.3V \pm 0.3V^{(1)}$		$V_{CCB}=5V \pm 0.5V^{(1)}$		UNIT
				MIN	MAX	MIN	MAX	MIN	MAX	MIN	MAX	
t_{PLH}	A	B	Full	2.7	24.5	1.8	16.5	1.5	15.4	1.3	16.6	ns
t_{PHL}				2.5	18.4	1.6	12.7	1.5	11.3	1	10.4	

(1) This parameter is ensured by design and/or characterization and is not tested in production.

8.5.3 $V_{CCA}=3.3V\pm 0.3V$

over recommended operating free-air temperature range, Full=-40°C to 125°C.

PARAMETER	FROM (INPUT)	TO (OUTPUT)	TEMP	$V_{CCB}=1.8V \pm 0.15V^{(1)}$		$V_{CCB}=2.5V \pm 0.2V^{(1)}$		$V_{CCB}=3.3V \pm 0.3V^{(1)}$		$V_{CCB}=5V \pm 0.5V^{(1)}$		UNIT
				MIN	MAX	MIN	MAX	MIN	MAX	MIN	MAX	
t_{PLH}	A	B	Full	2.5	23.2	1.6	16.2	0.8	15.2	0.8	15.1	ns
t_{PHL}				2.4	15.3	1.5	12.5	0.9	10.2	0.8	10	

(1) This parameter is ensured by design and/or characterization and is not tested in production.

8.5.4 $V_{CCA}=5V\pm 0.5V$

over recommended operating free-air temperature range, Full=-40°C to 125°C.

PARAMETER	FROM (INPUT)	TO (OUTPUT)	TEMP	$V_{CCB}=1.8V \pm 0.15V^{(1)}$		$V_{CCB}=2.5V \pm 0.2V^{(1)}$		$V_{CCB}=3.3V \pm 0.3V^{(1)}$		$V_{CCB}=5V \pm 0.5V^{(1)}$		UNIT
				MIN	MAX	MIN	MAX	MIN	MAX	MIN	MAX	
t_{PLH}	A	B	Full	2.2	23.2	1.2	16.2	0.7	15.8	0.6	15.2	ns
t_{PHL}				2.1	14.1	1	11.4	0.8	10.4	0.6	9.5	

(1) This parameter is ensured by design and/or characterization and is not tested in production.

8.6 Operating Characteristics

$T_A=25^\circ C$

PARAMETER ⁽¹⁾		CONDITIONS	$V_{CCA}=V_{CCB}=1.8V$	$V_{CCA}=V_{CCB}=2.5V$	$V_{CCA}=V_{CCB}=3.3V$	$V_{CCA}=V_{CCB}=5V$	UNIT
			TYP	TYP	TYP	TYP	
C_{pdA}	A-port input, B-port output	$C_L=0$, $f=10MHz$, $t_r=t_f=5ns$	3	4	6	9	pF
C_{pdB}	A-port input, B-port output	$C_L=0$, $f=10MHz$, $t_r=t_f=5ns$	14	16	21	32	pF

(1) Power dissipation capacitance per transceiver.

8.7 Typical Characteristics

NOTE: The graphs and tables provided following this note are a statistical summary based on a limited number of samples and are provided for informational purposes only.

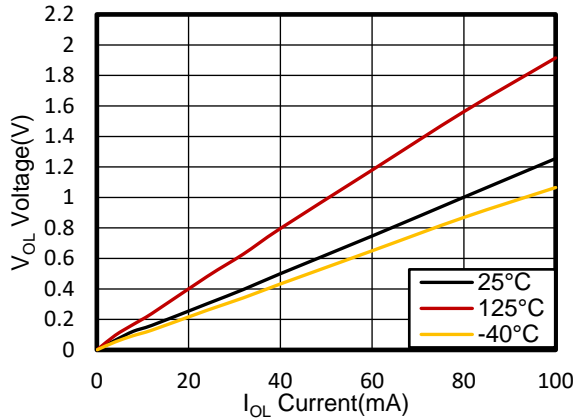

Figure 1. Voltage vs Current

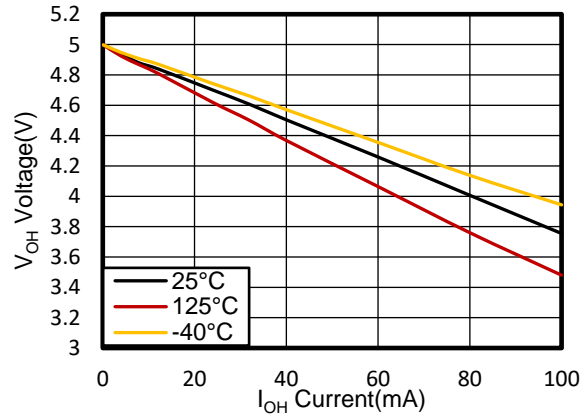
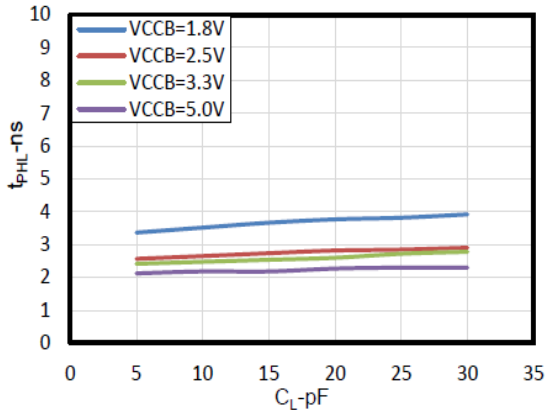
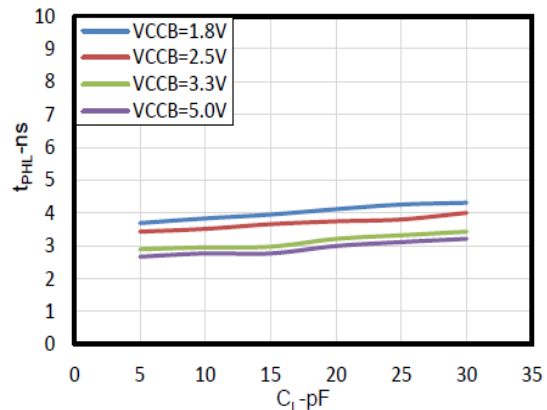

Figure 2. Voltage vs Current



$T_A = 25^\circ\text{C}$, $V_{CCA} = 1.8\text{ V}$

Figure 3. Typical Propagation Delay of High-to-Low (A to B) vs Load Capacitance



$T_A = 25^\circ\text{C}$, $V_{CCA} = 2.5\text{ V}$

Figure 4. Typical Propagation Delay High-to-Low (A to B) vs Load Capacitance

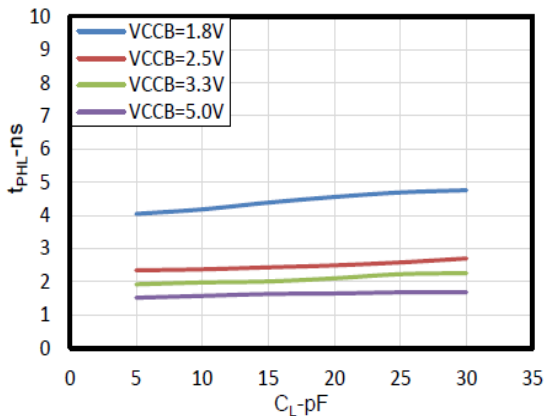

$T_A = 25^\circ\text{C}$, $V_{CCA} = 3.3\text{ V}$

Figure 5. Typical Propagation Delay High-to-Low (A to B) vs Load Capacitance

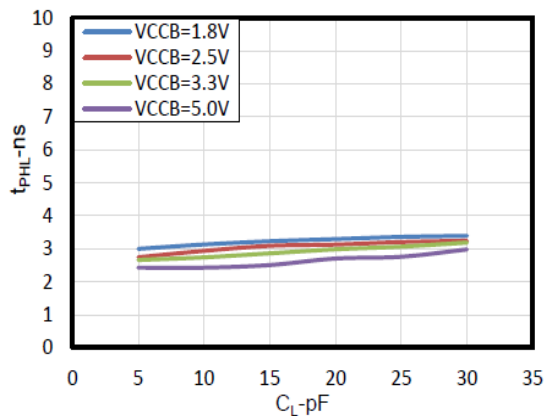

$T_A = 25^\circ\text{C}$, $V_{CCA} = 5\text{ V}$

Figure 6. Typical Propagation Delay High-to-Low (A to B) vs Load Capacitance

9 Parameter Measurement Information

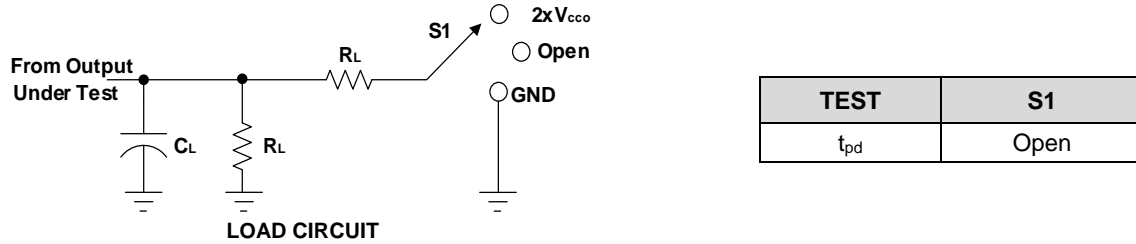

V_{CC}	C_L	R_L	V_{TP}
$1.8V \pm 0.15V$	15pF	2k Ω	0.15V
$2.5V \pm 0.2V$	15pF	2k Ω	0.15V
$3.3V \pm 0.3V$	15pF	2k Ω	0.3V
$5V \pm 0.5V$	15pF	2k Ω	0.3V

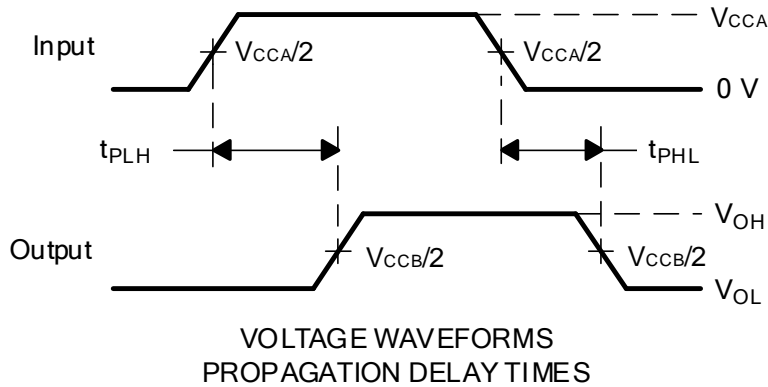

- NOTES: A. C_L includes probe and jig capacitance.
 B. All input pulses are supplied by generators having the following characteristics: $PRR \leq 10$ MHz, $Z_o = 50 \Omega$, $dv/dt \geq 1V/ns$.
 C. The outputs are measured one at a time, with one transition per measurement.
 D. t_{PLH} and t_{PHL} are the same as t_{pd} .
 E. V_{CCA} is the V_{CC} associated with the input port.
 F. All parameters and waveforms are not applicable to all devices.

Figure 7. Load Circuit and Voltage Waveforms

10 Application Information

The RS1T34 can be used in level-translation applications for interfacing devices or systems operating at different interface voltages with one another.

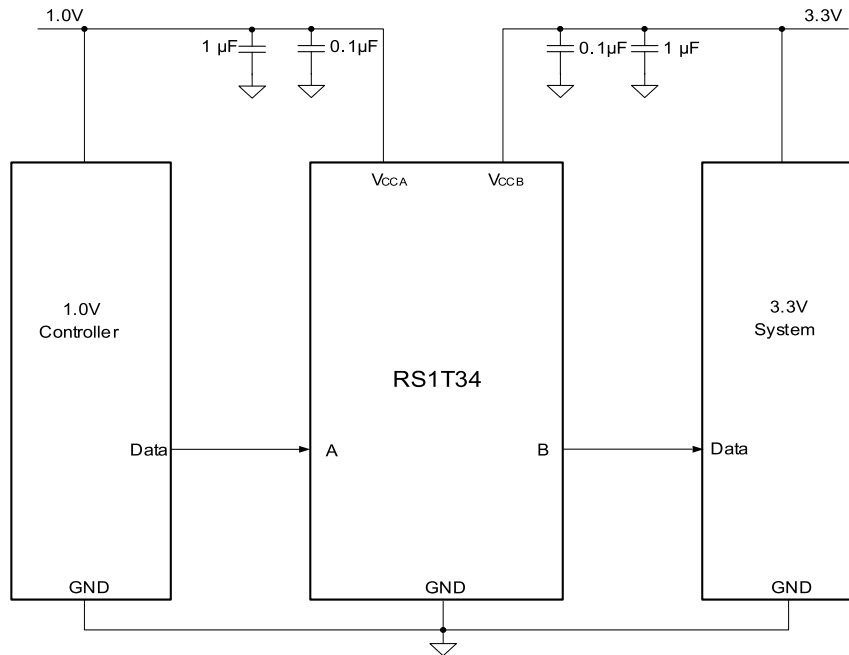
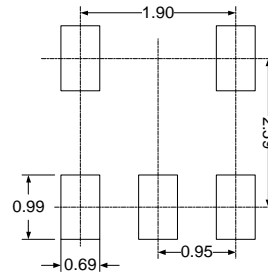
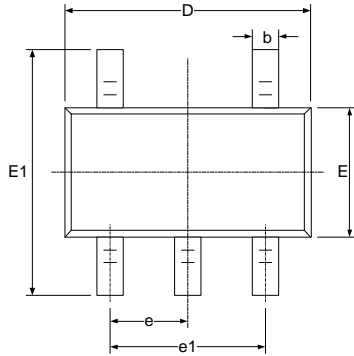

Figure 8. Typical Application Circuit

11 PACKAGE OUTLINE DIMENSIONS

SOT23-5



RECOMMENDED LAND PATTERN (Unit: mm)

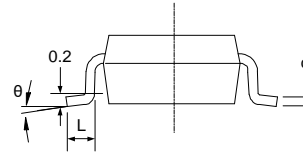
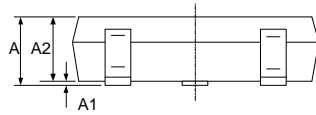

Symbol	Dimensions In Millimeters		Dimensions In Inches	
	Min	Max	Min	Max
A	1.050	1.250	0.041	0.049
A1	0.000	0.100	0.000	0.004
A2	1.050	1.150	0.041	0.045
b	0.300	0.500	0.012	0.020
c	0.100	0.200	0.004	0.008
D	2.820	3.020	0.111	0.119
E	1.500	1.700	0.059	0.067
E1	2.650	2.950	0.104	0.116
e	0.950 (BSC)		0.037 (BSC)	
e1	1.800	2.000	0.071	0.079
L	0.300	0.600	0.012	0.024
θ	0°	8°	0°	8°

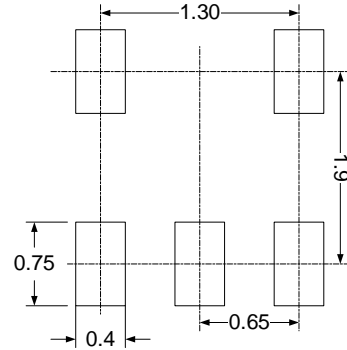
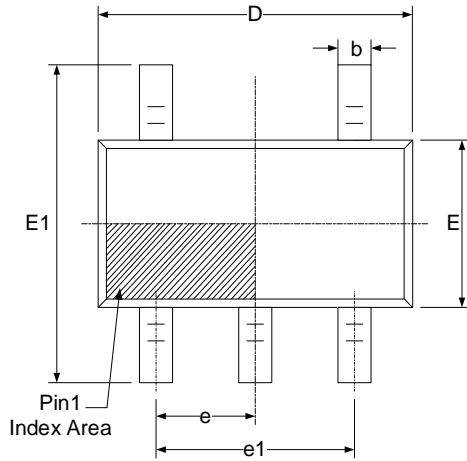
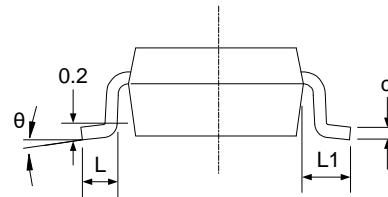
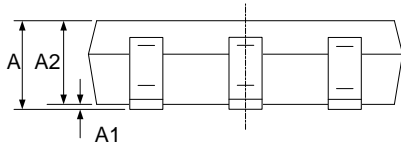
SOT353(SC70-5)

RECOMMENDED LAND PATTERN (Unit: mm)

Symbol	Dimensions In Millimeters		Dimensions In Inches	
	Min	Max	Min	Max
A	0.900	1.100	0.035	0.043
A1	0.000	0.100	0.000	0.004
A2	0.900	1.000	0.035	0.039
b	0.150	0.350	0.006	0.014
c	0.080	0.150	0.003	0.006
D	2.000	2.200	0.079	0.087
E	1.150	1.350	0.045	0.053
E1	2.150	2.450	0.085	0.096
e	0.650 (BSC)		0.026 (BSC)	
e1	1.300 (BSC)		0.051 (BSC)	
L	0.260	0.460	0.010	0.018
L1	0.525		0.021	
θ	0°	8°	0°	8°

NOTE:

- A. All linear dimension is in millimeters.
- B. This drawing is subject to change without notice.
- C. Body dimensions do not include mold flash or protrusion. Mold flash and protrusion shall not exceed 0.15 per side.
- D. BSC: Basic Dimension. Theoretically exact value shown without tolerances.

12 TAPE AND REEL INFORMATION

REEL DIMENSIONS

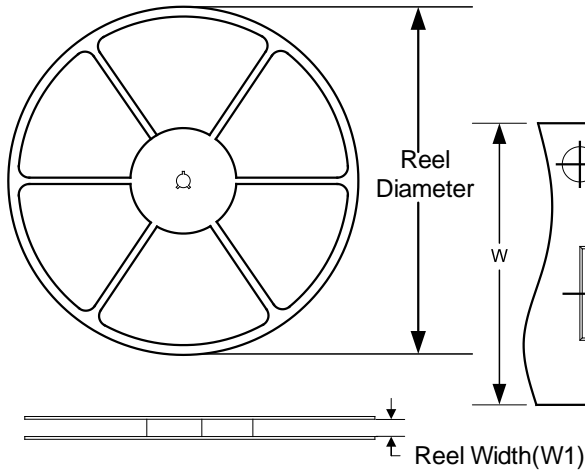

TAPE DIMENSION

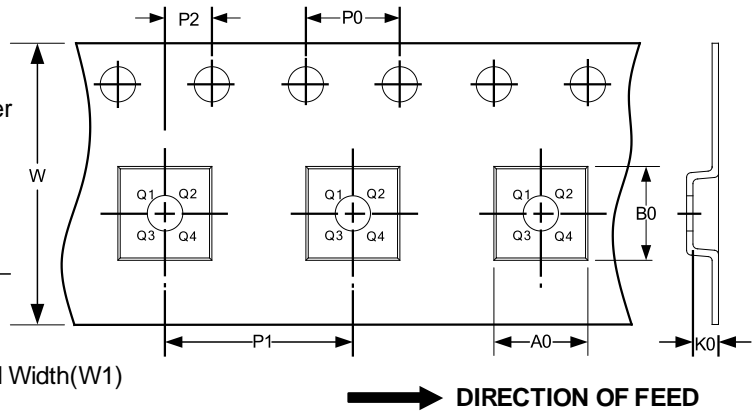

NOTE: The picture is only for reference. Please make the object as the standard.

KEY PARAMETER LIST OF TAPE AND REEL

Package Type	Reel Diameter	Reel Width (mm)	A0 (mm)	B0 (mm)	K0 (mm)	P0 (mm)	P1 (mm)	P2 (mm)	W (mm)	Pin1 Quadrant
SOT23-5	7"	9.5	3.20	3.20	1.40	4.0	4.0	2.0	8.0	Q3
SOT353 (SC70-5)	7"	9.5	2.25	2.55	1.20	4.0	4.0	2.0	8.0	Q3

NOTE:

1. All dimensions are nominal.
2. Plastic or metal protrusions of 0.15mm maximum per side are not included.

IMPORTANT NOTICE AND DISCLAIMER

Jiangsu Runic Technology Co., Ltd. will accurately and reliably provide technical and reliability data (including data sheets), design resources (including reference designs), application or other design advice, WEB tools, safety information and other resources, without warranty of any defect, and will not make any express or implied warranty, including but not limited to the warranty of merchantability Implied warranty that it is suitable for a specific purpose or does not infringe the intellectual property rights of any third party.

These resources are intended for skilled developers designing with Runic products You will be solely responsible for: (1) Selecting the appropriate products for your application; (2) Designing, validating and testing your application; (3) Ensuring your application meets applicable standards and any other safety, security or other requirements; (4) Runic and the Runic logo are registered trademarks of Runic Incorporated. All trademarks are the property of their respective owners; (5) For change details, review the revision history included in any revised document. The resources are subject to change without notice. Our company will not be liable for the use of this product and the infringement of patents or third-party intellectual property rights due to its use.